

## ENERGIZER L91 Ultimate Lithium

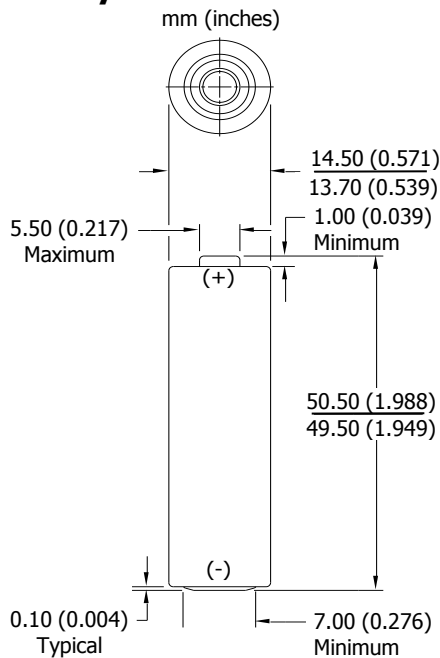

**AA**

### Industry Standard Dimensions



### Specifications

<b>Classification:</b>	"Cylindrical Primary Lithium"
<b>Chemical System:</b>	Lithium/Iron Disulfide (Li/FeS <sub>2</sub> )
<b>Designation:</b>	ANSI 15-LF, IEC-FR14505 (FR6)
<b>Nominal Voltage:</b>	1.5 Volts
<b>Sizing Compatibility:</b>	E91 NH15 1215
<b>Storage Temp:</b>	-40°C to 60°C (-40°F to 140°F)
<b>Operating Temp:</b>	-40°C to 60°C (-40°F to 140°F)*
<b>Typical Weight:</b>	15 grams (0.5 oz.)
<b>Typical Volume:</b>	8.0 cubic centimeters (0.49 cubic inch)
<b>Max Discharge:</b>	2.5 amps continuous
(single battery only)	4.0 amps pulse (2 sec on / 8 sec off)
<b>Lithium Content:</b>	Less than 1 gram
<b>Typical IR:</b>	120 to 240 milliohms (depending on method)
<b>Shelf Life:</b>	20 years at 21°C
<b>More Details:</b>	<a href="#">On-Line Catalog-Application Manual (Li/FeS<sub>2</sub>)</a>
<b>Shipping:</b>	Please refer to PSDS Document
<b>Certifications:</b>	This battery has Underwriters Laboratories component recognition (MH29980) Compliant to intrinsic safety 710024 II 1G Ex ia IIC Ga Baseefa 14ATEX0107U

**\*All data shown tested at 21°C unless otherwise stated.**

### Milliamp-Hours Capacity

Constant Current Discharge to 0.8 Volts

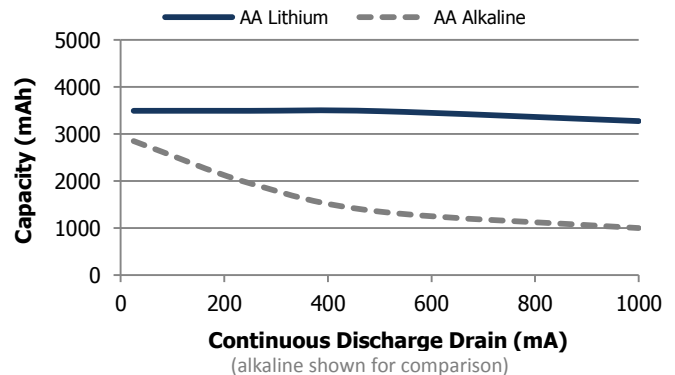

### Discharge Profile

Constant Current Discharge

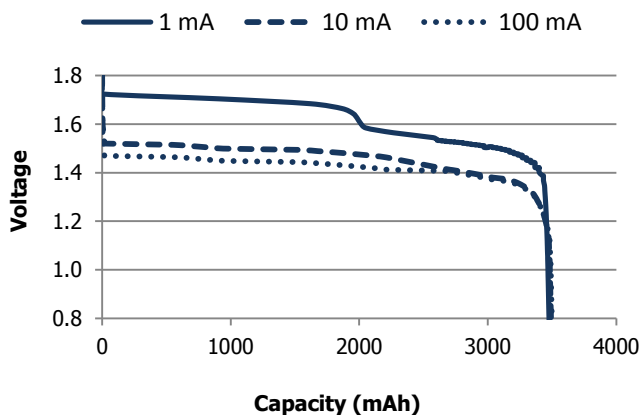

### Temperature Effects on Capacity

Constant Current Discharge

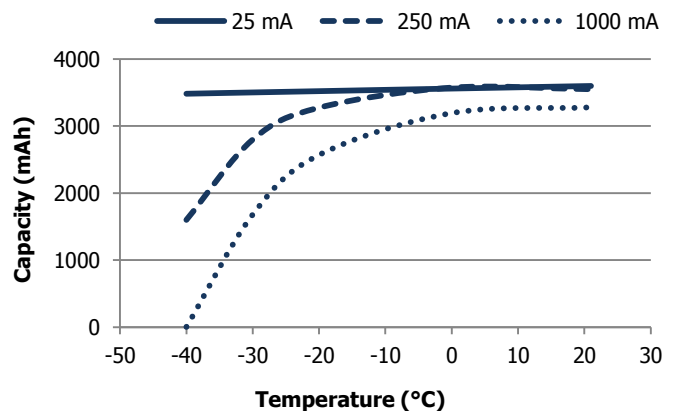

### Important Notice

This datasheet contains typical information specific to products manufactured at the time of its publication.  
**©Energizer Brands, LLC - Contents herein do not constitute a warranty.**

# ENERGIZER L91



## Internal Resistance Profile

Cell Ohmic Resistance - Dual Pulse Method

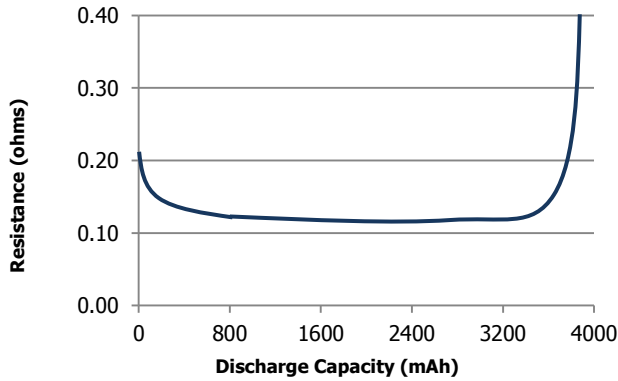

## Pulse Response

Open Circuit Voltage - 100/500/1k mA Pulse

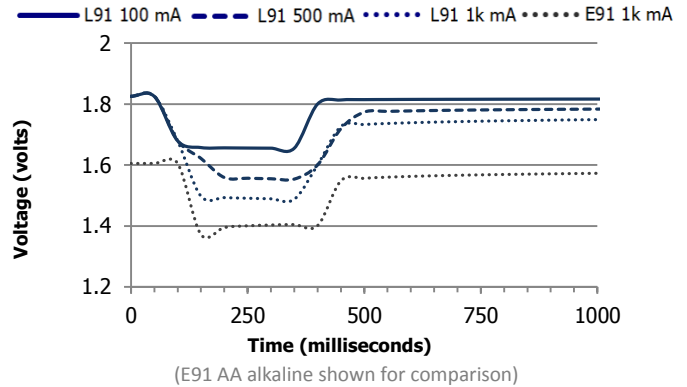

## Constant Power Performance

Typical Characteristics to 0.8 Volts

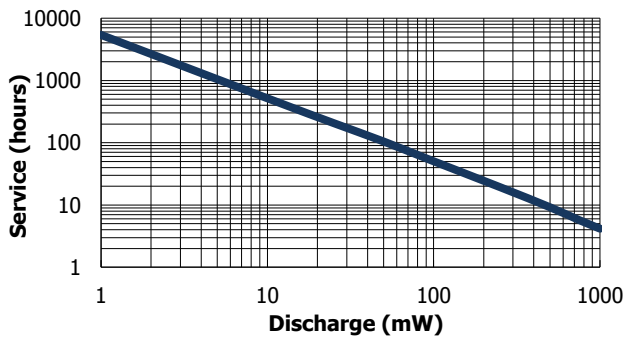

## Constant Current Performance

Typical Characteristics to 0.8 Volts

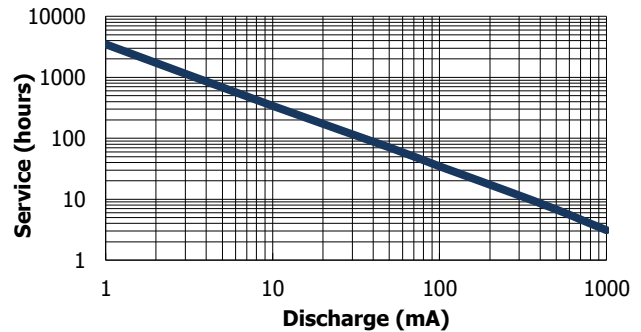

## Application Tests

REMOTE/RADIO /CLOCK  
50 mA 1 hr/8 hrs day

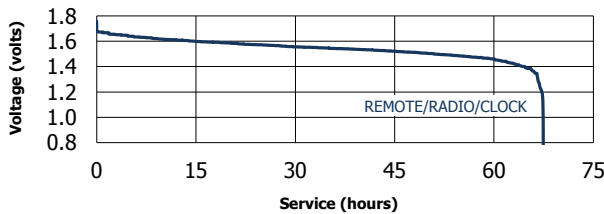

## Application Tests

CD/GAMES  
250 mA 1 hr/day

DIGITAL AUDIO  
100 mA 1 hr/day

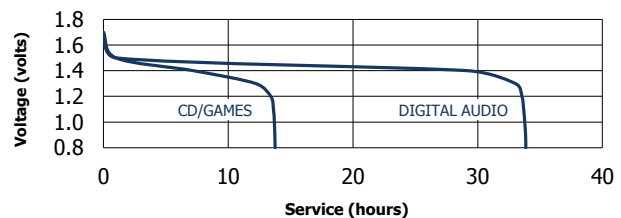

## Application Tests

PORTABLE LIGHTING  
3.3 ohm LIF

TOY  
3.9 ohm 1 hr/day

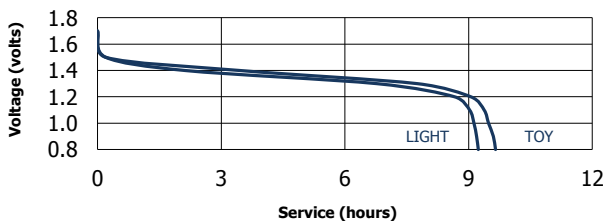

## Industry Standard Tests

PERSONAL GROOMING  
750 mA 2 min/hr 8 hrs/day

DIGITAL CAMERA  
1.5/.65K mW 2/.1/27.9s 10X

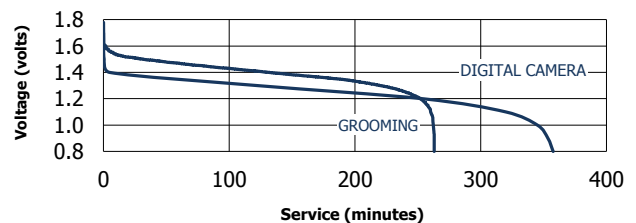

### Important Notice

This datasheet contains typical information specific to products manufactured at the time of its publication.  
©Energizer Brands, LLC - Contents herein do not constitute a warranty.